

STÚTAR DIFFUSERS

Beinn buna, árásarstútur og gleiðhorns úða. Í (anodiseruðu) sér hertu áli eða ryðfríu stáli. fjarstýrt val á flæðimynstri og flæðihraða. *Straight stream, attack spray and wide angle spray. In anodised aluminium alloy or stainless steel. Motorised selection of flow pattern and flow rate.*

STÚTAR MEÐ FJARSTÝRINGU DIFFUSERS WITH AUTOREGULATION



STÚTUR AUTOKADOR 5000
DIFFUSER AUTOKADOR 5000



STÚTUR AUTOKADOR INOX 3000
DIFFUSER AUTOKADOR INOX 3000

STÚTAR MEÐ FÖSTU RENNSLISFLÆÐI DIFFUSERS WITH FIXED FLOW RATE



STÚTUR POKADOR 2000
DIFFUSER POKADOR 2000



STÚTUR POKADOR INOX 2000
DIFFUSER POKADOR INOX 2000

STÚTAR MEÐ STILLANLEGU RENNSLI OG ÚÐA MYNSTRI DIFFUSERS WITH SELECTABLE FLOW RATE AND FLOW PATTERN



STÚTUR DÉBIKADOR 5000
DIFFUSER DÉBIKADOR 5000

KÚPLINGAR COUPLINGS



STORZ NST GFR MACHINO GOST DSP BARCELONA INSTANTANEOUS

PLA_01080_Flyer IS-EN_Motordrífur monitorar_Motorised Monitors

MOTORDRIFNIR MONITORAR
MOTORISED MONITORS

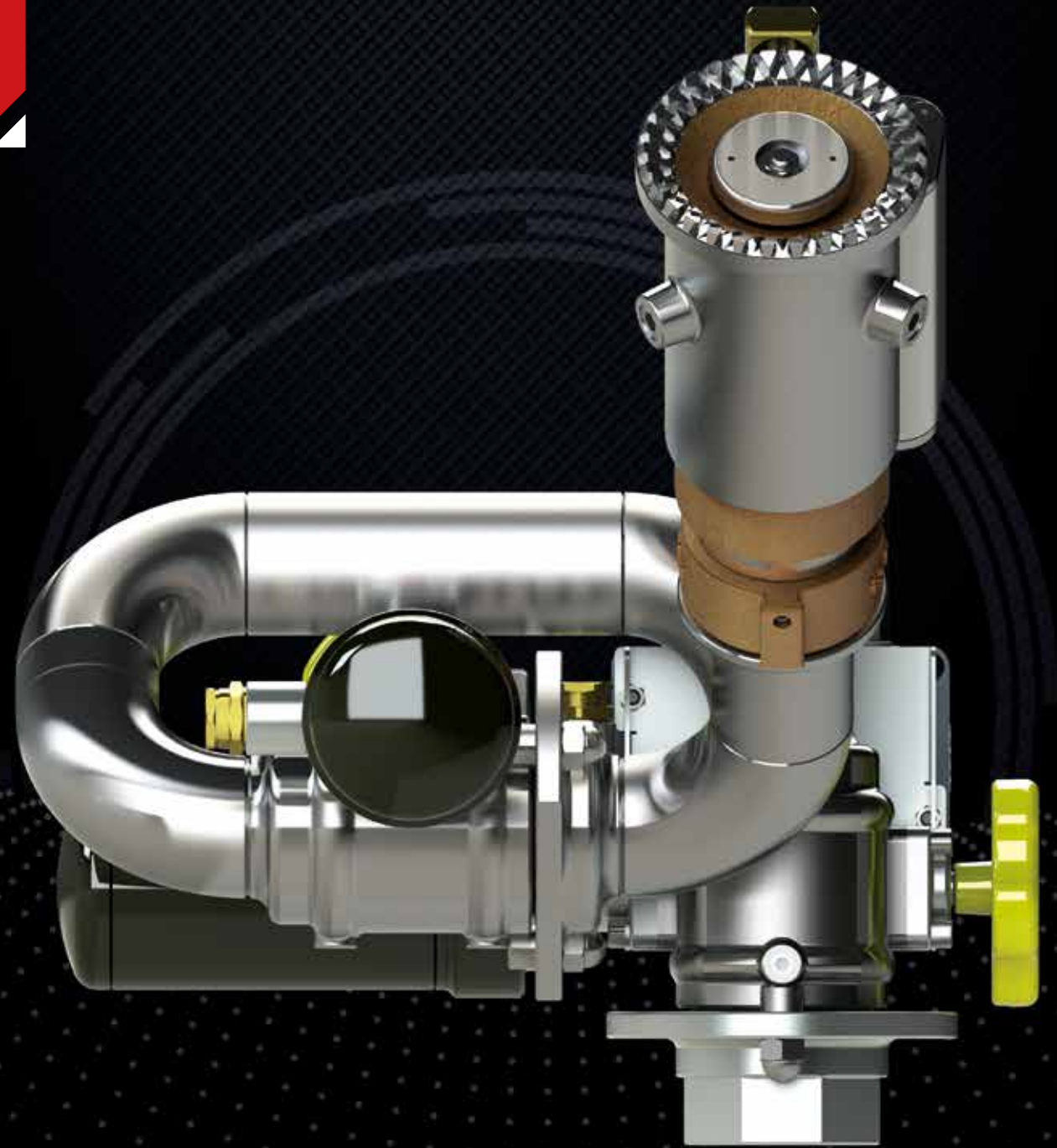

POK SAS

18 Cours Antoine Lavoisier - 10400 Nogent-sur-Seine - FRANCE
Tél. : +33 (0)3 25 39 84 78 - Fax : +33 (0)3 25 39 84 90
info@pok.fr export@pok-fire.com www.pok.fr



YouTube



GÆÐA FRAMLEIÐSLA / WE CREATE WITH PASSION



DN 65 FÆRANLEGIR MONITORAR PORTABLE MONITORS

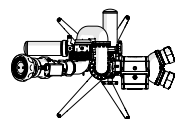

Fjarstýrður, stjórnast með stýripinna (joystick) og rafhlöðu, rennslis hraði allt að 2400 L/mín.

Totally independent thanks to its battery and remote control, transportable, offers a flow rate up to 2400 lpm (gradual movements with the joystick).

- ▶ Inntak : hann/male 2"1/2 NST-NH / Inlet: male 2.5" NST-NH
 - ▶ Ø Dísu : 65 mm / Waterway Ø: 65 mm
 - ▶ Þrýstingur : PN16 / Nominal pressure: PN 16
 - ▶ Efni : álblanda / Material: aluminium alloy
 - ▶ Yfirborð : polyester húðun og sér hert (anodisation)
 - ▶ Surface treatment: polyester coating and hard anodisation
 - ▶ Lárétt færsla : yfir 360° / Horizontal movement: over 360°
 - ▶ Lárétt stilling : fjarstýring, einng handstjórnun
 - ▶ Horizontal adjustment: motorised and spare handwheel
 - ▶ Lóðrétt færsla : frá +32° til +90° / Vertical movement: from +32° to +90°
 - ▶ Lóðrétt stilling : fjarstýring, einnig hand stjórnun með spindli / Vertical adjustment: motorised and spare handwheel
 - ▶ Aflgjafi : 24V CC / Power supply: 24V CC
 - ▶ Hraði : 22°/s / Speed: 22°/s
 - ▶ Öryggi : læsing á fótum, festingaról / Safety: locking of the legs, anchoring strap
 - ▶ Burðar handfang : Já / Carrying handle: YES
 - ▶ Samanbrjótanlegir fætur : Já / Foldable legs: YES
 - ▶ Valkostir : inntakstenging, úttaksbúnaður, stjórnkerfi, vagn/kerri
- Options: inlet coupling, outlet equipment, control system, trolley

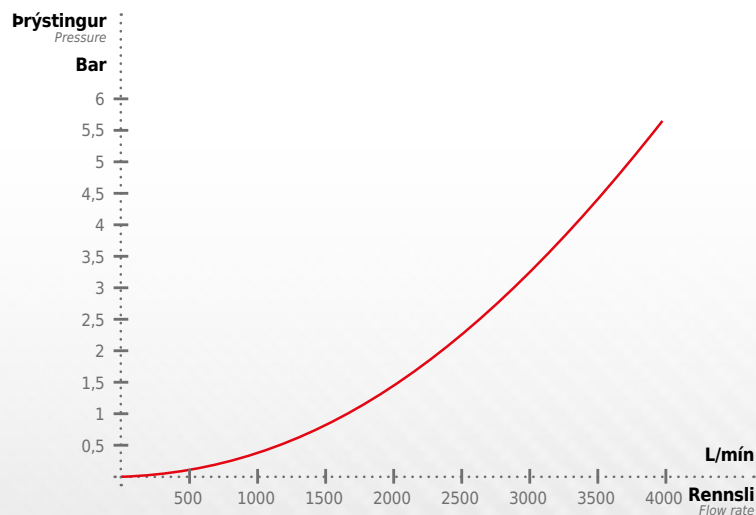

Höfum skift út einföldu útgáfunni (2 hraðastýringu) yfir í fullkomnari (allt að 5 ása), sem eru fullkomnastu fjarstýringar á markaðnum.
Going from the simplest version (2 speed control) to the more complete (up to 5 axes), the most complete range of remote controls on the market.

MCR - Lítil (mini) fjarstýring : leiðandi og einföld í notkun og mjög nákvæm.
MCR - Mini Remote Control: intuitive and simple for a better monitoring precision.

- Fjarstýring með sjálfvirkum hljóðgervli (16 tíðnir) - 433 - 434 MHz
- Radio with automatic frequency synthesiser (16 frequencies) - 433 - 434 MHz
- Dregur 150 m á opnu svæði / Range of radio transmission: 150 m in free-field
- Stærð á sendinum (LxH): 155 x 78 x 33 mm
- Stærð á móttakara (LxH): 155 x 78 x 33 mm
- Þyngd á sendinum : 280 g með rafhlöðuwith / Weight of the transmitter: 280 g with battery
- Þyngd á móttakara (LxH): 155 x 78 x 33 mm
- Dimensions of the receiver (LxH): 155 x 78 x 33 mm
- Vatnsvöm : IP66 / Waterproof protection class: IP66
- Vinnu hitastig : frá -30°C til +70°C / Operation temperature: from -30°C to +70°C
- Fjarstýrðar aðgerðir : Hækkun (hlutfallsstýring)
- Lárétt (hlutfallsstýring með sjálfvirkri færslu)
- Úðari/stútur (on-off control) - Neyðarstöðvun
- Remote-controlled functions: Elevation (proportional control)
- Horizontal (proportional control with automatic sweeping option)
- Diffuser (on-off control) - Emergency stop

FULL V2 : fjarstýrikerfið býður upp á ótal möguleika til að stjórna föstum monitorum.
FULL V2: the most comprehensive system to control fixed monitors with an extensive number of options.

- ▶ Fjarstýring með sjálfvirkum hljóðgervli (16 tíðnir) - 433 - 434 MHz
- Radio with automatic frequency synthesiser (16 frequencies) - 433 - 434 MHz
- ▶ Fjarstýringin dregur : 300 m á opnu svæði / Range of radio transmission: 300 m in free-field
- ▶ Stærð sendis (LxH): 170 x 85 x 137 mm
- Dimensions of the transmitter (LxH): 170 x 85 x 137 mm
- ▶ Þyngd sendis 1,970 Kg með rafhlöðu / Weight of the transmitter: 1,970 Kg with battery
- ▶ Stærð móttakara (LxH): 224 x 130 x 87 mm
- Dimensions of the receiver (LxH): 224 x 130 x 87 mm
- ▶ Vatnsvöm : IP66 / Waterproof protection class: IP66
- ▶ Vinnu hitastig frá -30°C til +70°C / Operation temperature: from -30°C to +70°C
- ▶ Fjarstýrðar aðgerðir : Hækkun (hlutfallsstýring) - Lárétt (hlutfallsstýring með sjálfvirkri færslu) - Úðari/stútur (on-off stjórn) - Blabbermouth (opnun á kjalti) (on-off stjórn)
- Stíllanlegur rennslis hraði (stjórnæki til að slökkva á) - Sjónauki rör (upp og niður) - Loki (opið / lokað) - Neyðarstöðvun
- Remote-controlled functions: Elevation (proportional control) - Horizontal (proportional control with automatic sweeping option) - Diffuser (on-off control) - Blabbermouth (on-off control)
- Adjustable flow rate (on-off control) - Telescopic tube (up and down) - Valve (open / close) - Emergency stop



TECHNO V2 : Stjórnborðið fyrir iðnaðarmannvirki.
TECHNO V2: THE control panel for industrial installations.

- Aflgjafi : 230 VAC - 16A - 50 Hz / Power supply: 230 VAC - 16 A - 50 Hz
- Hægt að fá vara rafhlöðu (sem back up) 24V - 18 Ah / Spare batteries (optional) 24 V - 18 Ah
- Notkun : Handvirk : Stjórnun hreyfinga með fjarstýringunni.
- Sjálfvirk stjórnun/hreyfing með fjarstýringu í gegnum hitamyndavél
- Operation modes: Manual: control of the movements with the remote control - Automatic: automatic sweeping actioned from external data source (hot spot detection)
- Stíllanlegar aðgerðir með því að nota : Rafþrætt stopp - Árásarstaða monitorsins, staðsetning monitorsins, staðsetningar skjár (valfrjálst)

- Configurable functions by learning: Electronic stops - Attack position of the monitor
- Parking position of the monitor - Position display (optional)
- Fjarstýrðar aðgerðir : Hækkun (með stigskiftri færslu)
- Lárétt (Stýring með sjálfvirkri færslu) - Úðari /stútur (on-off control)
- Loki (opið / lokað) - Neyðarstöðvun
- Remote-controlled functions: Elevation (proportional control with sweeping option)
- Horizontal (proportional control with automatic sweeping option) - Diffuser (on-off control)
- Valve (open / close) - Emergency stop



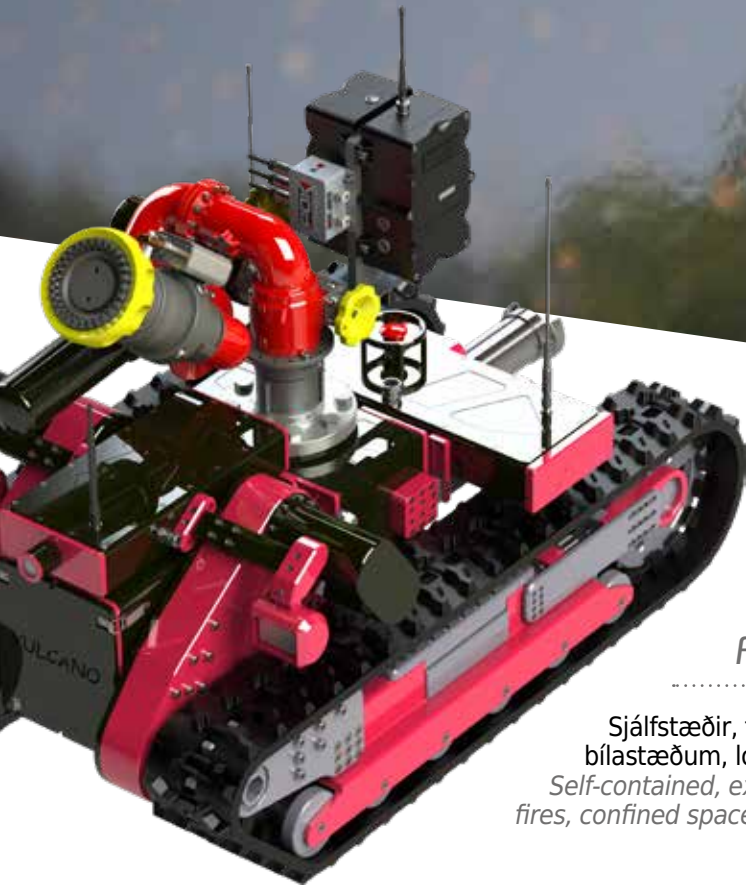

MONITORAR VÉLFÆRAFRÆÐI FASTIR MONITORAR FIXED MONITORS

Sjálfstæðir, framúrskarandi flutningsgeta, jarðgöng, eldar á bílastæðum, lokuðu rými, hættulegum svæðum.
Self-contained, excellent crossing capacity, tunnel fires, parking lot fires, confined spaces, hostile environments.

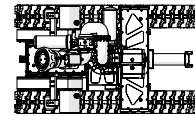

Monitor : LMP65 RC - Réf. : 26544 / Monitor: LMP65 RC - Ref.: 26544 ◀
Úðari / stútur : Autokador 3000 - Réf. : 29209 / Diffuser: Autokador 3000 - Ref.: 29209 ◀

Eiginleikar Róbótans / Robot characteristics

Stærð (LxlxH) : 1230 x 720 x 970 mm / Dimensions (LxlxH): 1230 x 720 x 970 mm ◀

Þyngd : 200 kg / Weight: 200 kg ◀

Vinnu tími : 2/4h / Duration: 2/4 hours ◀

Burðargeta : 200 kg / Payload: 200 kg ◀

Hraði : 4 km/h / Speed: 4 km/h ◀

Hæð frá jörðu : 20 cm / Obstacle clearance: 20 cm ◀

Halli : 45° / Slope: 45° ◀

Hliðar halli : 35° / Side slope: 35° ◀

Ryðvarinn : Já / Anticorrosion treatment: Yes ◀

Stjómunar vegalengd á opnu svæði : 300 metrar / Monitoring distance in free field: 300 meters ◀

Möguleiki á myndbandssendingu ◀

Options: Numeric video transmission

Myndavél að framan 720p / Front camera 720p ◀

2 x Leds skjávarpar / 2 x Leds projectors

3 ja ás video stilling - x36 stækkun (zoom) nótt eða á degi ◀

Video turret 3 axis - Camera with zoom x36 (night and day)

Hita myndavél / Thermographic video camera ◀

Skinjarar : gas, hita, laser fjarlægðarmælir ◀

Sensors: gaz, temperature, laser telemeter

Auka rafhláða / Extra battery ◀

Tvöfalt hleðslutæki / Double charger ◀



MONTMIRAIL DC, DN 80 FÆRANLEGIR MONITORAR PORTABLE MONITORS

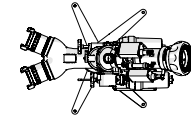

Einn sá allra léttasti, mjög meðfærilegur, býður upp á rennslisraða allt að 4000 L/mín (smá saman með stigmagnandi hreyfingum með stýripinnanum).
The lightest of its kind, easily portable, offers a flow rate up to 4000 lpm (gradual movements with the joystick).

Inntak : 2 x hann/male 2.5 BSP" / Inlets: 2 x male 2.5" BSP ◀

Ø Disu : 80 mm / Waterway Ø: 80 mm ◀

Þrýstingur : PN16 / Nominal pressure: PN16 ◀

Efni : álblanda / Material: aluminium alloy ◀

Yfirborð : polyester húðun og sér hert (anodization) ◀

Surface treatment: polyester coating and hard anodisation

Lárétt færsla : frá -180° til +180° ◀

Horizontal movement: from -180° to +180°

Lárétt stilling : fjarstýrð einnig handvirk með spindli ◀

Horizontal adjustment: motorised and spare handwheel

Lóðrétt færsla : frá +25° til +85° / Vertical movement: from +25° to +85° ◀

Lóðrétt stilling : Fjarstýrð og handvirk með spindli ◀

Vertical adjustment: motorised and spare handwheel

Hraði : 9°/s / Speed: 9°/s ◀

Aflgjafi : 24V CC / Power supply: 24V CC ◀

Öryggi : læsing á fótum, festingaról ◀

Safety: locking of the legs, anchoring strap

Burðar handfang : Já / Carrying handle: YES ◀

Samanbrjótanlegir fætur : Já / Foldable legs: YES ◀

Valkostir : inntakstenging, úttaksbúnaður, stjórnkerfi ◀

Options: inlet coupling, outlet equipment, control system

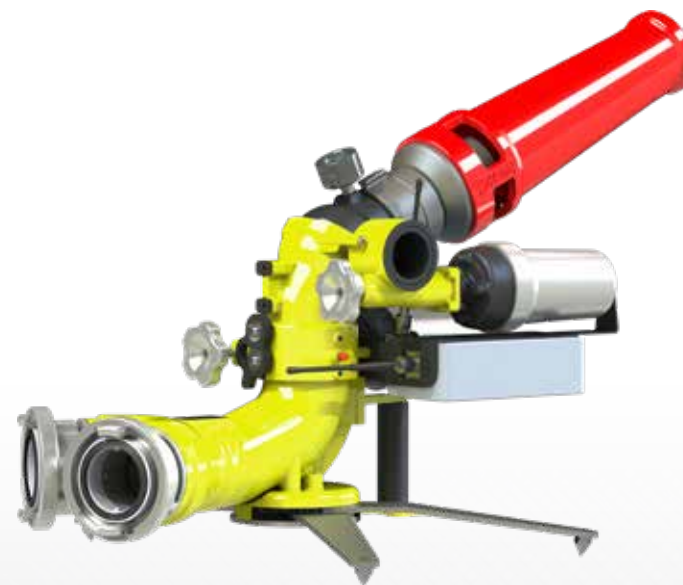
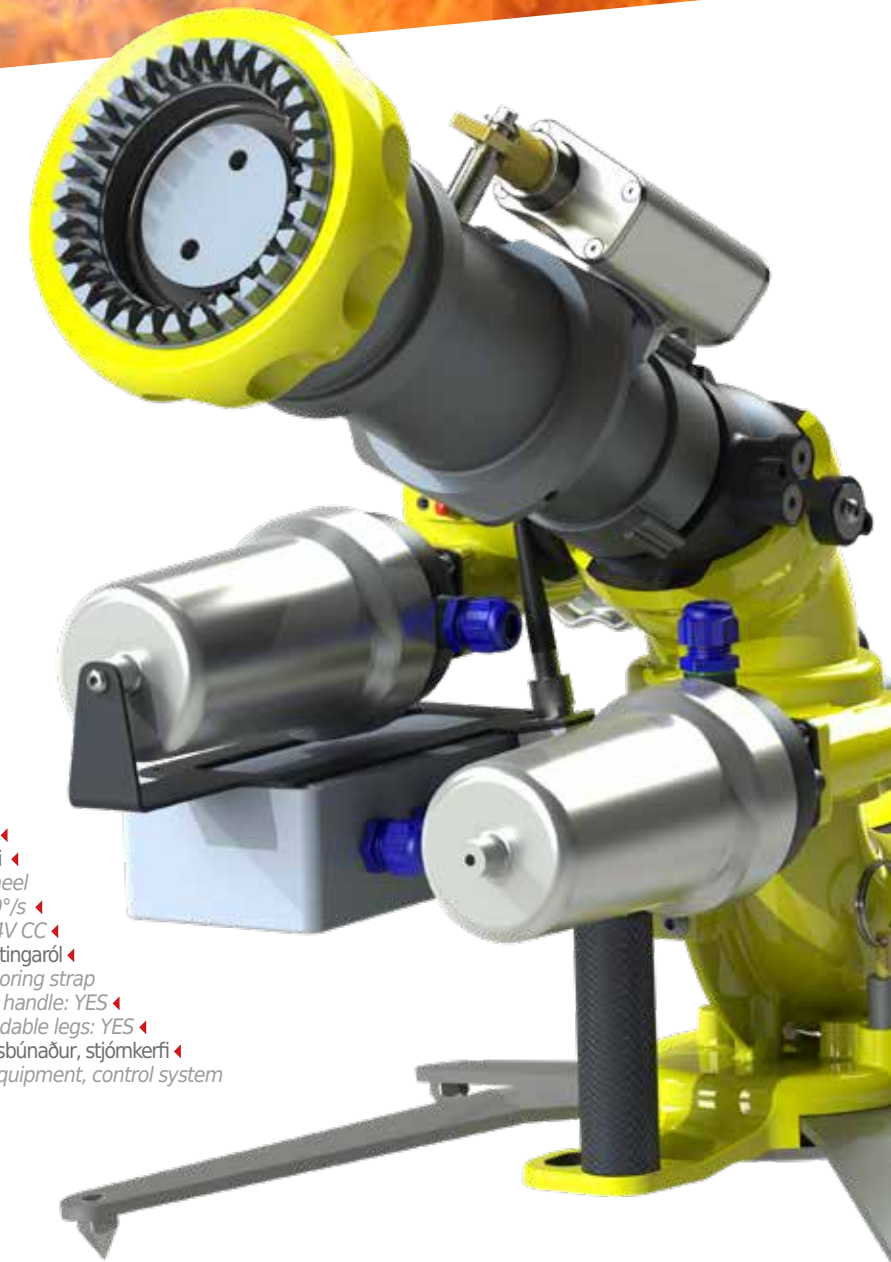

Þrýstingur
Pressure

Bar

3,5

3

2,5

2

1,5

1

0,5

Mesta þrýstitala Maxi. (bar) ○
Maxi. pressure loss (bar)

Minnsta þrýstitala Mini. (bar) ○
Mini. pressure loss (bar)

L/mín

1000

2000

3000

4000

Rennsli

Flow rate

Flow rate



DN 100 FASTIR MONITORAR FIXED MONITORS

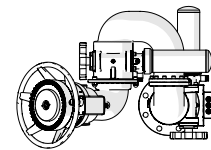

Mjög nettur og alveg fjarstýrður, og býður upp á rennslishraða allt að 7500 L/mín.
Very compact and entirely remote controlled, it offers a flow rate up to 7500 lpm.

- ▶ Inntak : 4" ASA 150 - PN20 flangs / Inlet: 4" ASA 150 - PN20 flange
- ▶ Ø Dísu : 100 mm / Waterway Ø: 100 mm
- ▶ Þrýstingur : PN16 / Nominal pressure: PN16
- ▶ Efni : álblanda / Material: aluminium alloy
- ▶ Yfirborð : polyester húðun og sér hert (anodization)
Surface treatment: polyester coating and hard anodisation
- ▶ Lárétt færsla : yfir 360° / Horizontal movement: over 360°
- ▶ Lárétt stilling : fjarstýrður einnig handstýrður með spindli / Horizontal adjustment: motorised and spare handwheel
- ▶ Lóðrétt færsla : frá -90° til +90° / Vertical movement: from -90° to +90°
- ▶ Lóðrétt stilling : fjarstýrður einnig handstýrður með spindli / Vertical adjustment: motorised and spare handwheel
- ▶ Hraði : 9°/s / Speed: 9°/s
- ▶ Aflgjafi : 24V CC / Power supply: 24V CC
- ▶ Valkostir : inntaksflans, úttaksbúnaður, stjómkerfi
Options: inlet flange, outlet equipment, control system

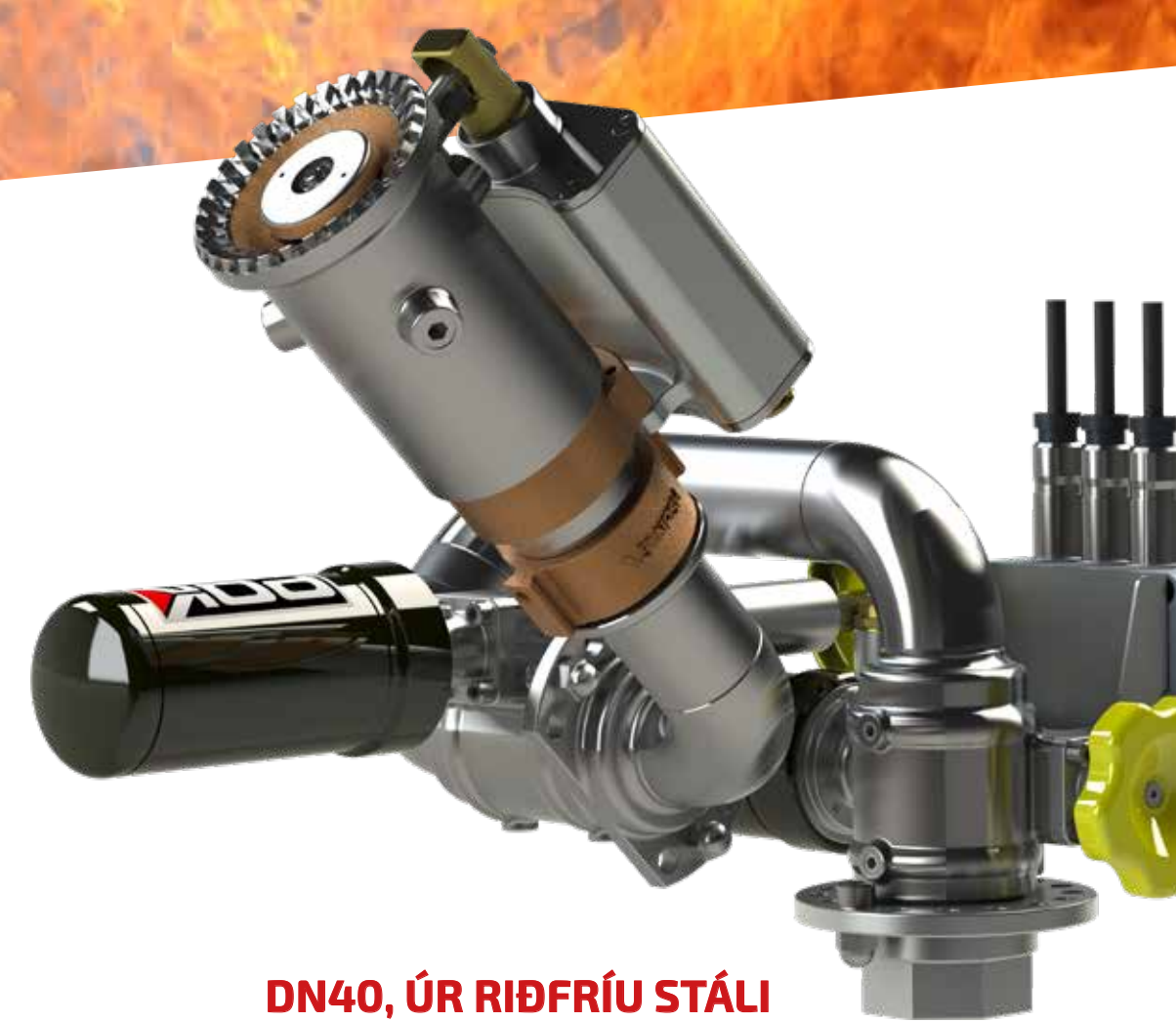
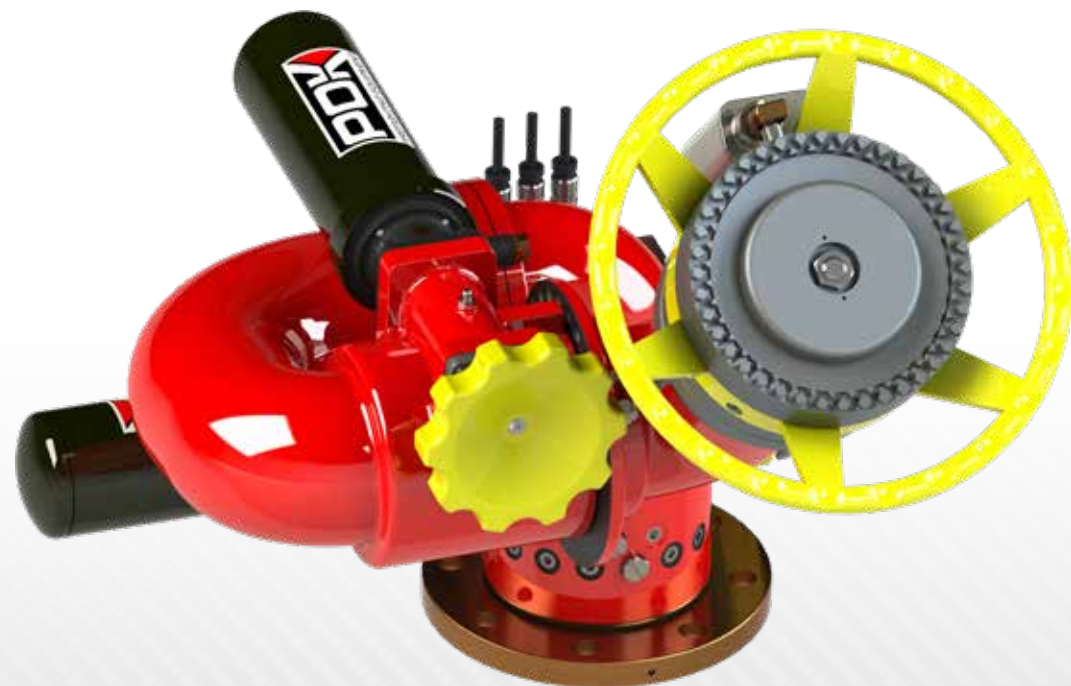

DN40, ÚR RIÐFRÍU STÁLI FASTIR MONITORAR FIXED MONITORS, IN STAINLESS STEEL

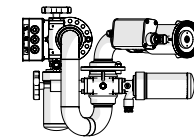

Fyrir tæki sem þurfa lítinn rennslisraða (1000 L/mín), og er fjarstýrður, tilvalinn fyrir ökutæki.
For applications that require a small flow rate (1000 lpm), entirely remote controlled, ideal for vehicles.

- ▶ Inntak : DN40 PN16 flangs / Inlet: DN40 PN16 flange
- ▶ Ø Dísu : 40 mm / Waterway Ø: 40 mm
- ▶ Þrýstingur : PN16 / Nominal pressure: PN16
- ▶ Efni : riðfrítt stál / Material: stainless steel
- ▶ Lárétt færsla : frá -170° til +170° / Horizontal movement: from -170° to +170°
- ▶ Lárétt stilling : fjarstýring og handstýring með spindli / Horizontal adjustment: motorised and spare handwheel
- ▶ Lóðrétt færsla : frá -90° til +90° / Vertical movement: from -90° to +90°
- ▶ Lóðrétt stilling : fjarstýring einnig handstýrður með spindli / Vertical adjustment: motorised and spare handwheel
- ▶ Aflgjafi : 24V CC / Power supply: 24V CC
- ▶ Hraði : 12°/s / Speed: 12°/s
- ▶ Valkostir : inntaksflans, úttaksbúnaður, stjómkerfi
Options: inlet flange, outlet equipment, control system

